

ROHS

1

2

3

4

		REVISIONS			
REV.	ECN NO.	LOCATION	DESCRIPTION	DATE	DESIGN
A1	ECN-P-2024111301		Interior P/N Change: XK03WMX Change XK1PWM11-ND04-X	2024.11.19	希文

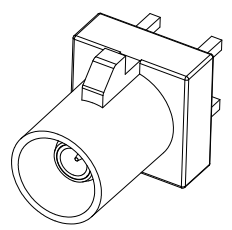
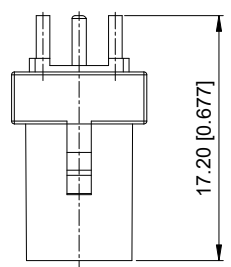

3D View

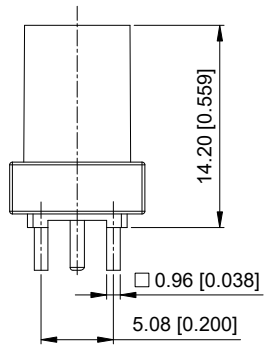
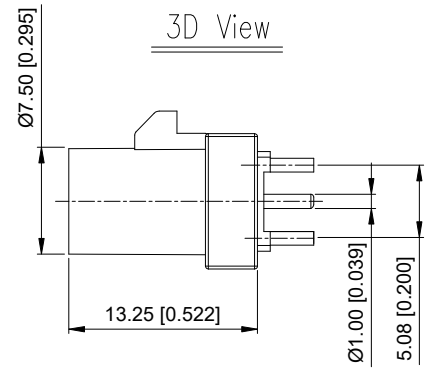
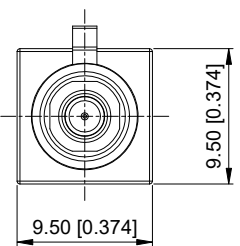

Specifications(规格):

1. Impedance(特性阻抗) : 50Ω;
2. Frequency(工作频率) : DC~6GHz;
3. Insulation resistance(绝缘阻抗) : ≥100MΩ;
4. VSWR(驻波比) : ≤1.50 @3GHz;
5. Dielectric withstand voltage(介质耐电压) : 800V AC;
6. Mating cycles(耐久性) : ≥25 cycles;
7. Engagement force(啮合力) : ≤25N;
8. Retention force latch(保持力) : ≥110N;
9. Temperature range(使用温度) : -40℃~+105℃;

PART NO.:

XK1PWM11-ND04-X

Code: A~Z

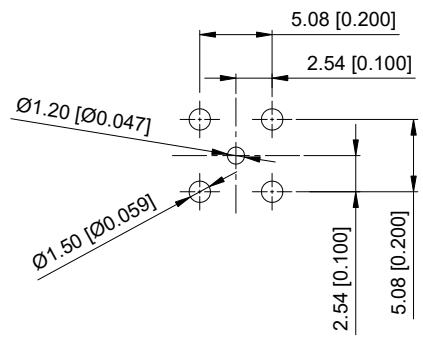

Recommended P.C.B Layout

ANGULAR	±5°
X.	±0.50
X.x	±0.30
X.xx	±0.20
X.xxx	±0.10

UNSPECIFIED TOLERANCES

4	Dielectric	PTFE		1 PC	
3	Outer Conductor	Copper Alloy	Ni PLATED	1 PC	
2	Center Conductor	Copper Alloy	Gold PLATED	1 PC	
1	Housing	PA66		1 PC	
NO.	SPEC.	MATERIAL	FINISH (Contact)	Q'TY	Note

www.helloxkb.com www.helloxkb.cn www.xk-dg.cn



DESIGN	希文	VIEW:	
CHECKED		UNIT:	mm/in
APPROVED		SIZE:	A4

MODEL TYPE:		
Vertical FAKRA Male Connector		
PART NO.:	XK1PWM11-ND04-X	
DWG NO.:	X-XK1PWM11-ND04-X	

XKB INDUSTRIAL PRECISION CO.,LIMITED

SCALE	PAGE	REVISION
N/A	1/2	A1

1

2

3

4











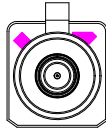
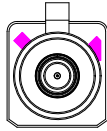
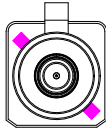

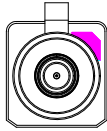
1

2

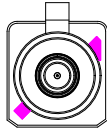
3

4

Code List:

Colde							
	A	B	C	D	E	F	G
Color/RAL-No.	Black/9005	White/9001	Blue/5005	Bordeaux/4004	Green/6002	Brown/8011	Grey/7031
PART NO.	XK1PWM11-ND04-A	XK1PWM11-ND04-B	XK1PWM11-ND04-C	XK1PWM11-ND04-D	XK1PWM11-ND04-E	XK1PWM11-ND04-F	XK1PWM11-ND04-G
Colde							
	H	I	K	L	M	N	Z
Color/RAL-No.	Violet/4003	Beige/1001	Curry/1027	Carmine red/3002	Pastel Orange/2003	Pastel Green/6019	Water Blue/5021
PART NO.	XK1PWM11-ND04-H	XK1PWM11-ND04-I	XK1PWM11-ND04-K	XK1PWM11-ND04-L	XK1PWM11-ND04-M	XK1PWM11-ND04-N	XK1PWM11-ND04-Z

ANGLAR	±5°
X.	±0.40
X.x	±0.30
X.xx	±0.20
X.xxx	±0.15
UNSPECIFIED TOLERANCES	



DESIGN	希文	VIEW:		MODEL TYPE:	Vertical FAKRA Male Connector
CHECKED		UNIT:	mm/in	PART NO.:	XK1PWM11-ND04-X
APPROVED		SIZE:	A4	DWG NO.:	X-XK1PWM11-ND04-X
			SCALE	PAGE	REVISION
			N/A	2/2	A1

NOTE: ALL RIGHTS RESERVED,BANNED COPY!

www.helloxkb.com www.helloxkb.cn www.xk-dg.cn

XKB INDUSTRIAL PRECISION CO.,LIMITED

1

2

3

4